

CABLE 3#18
FROM TRANSFORMER
(SEE DRAWING C-002 FOR
POWER REQUIREMENT)

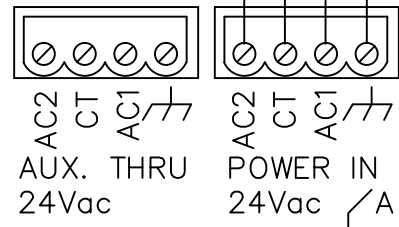

DATA ECHELON TYPE 2#18, STRANDED, 7/26 UTP
(UNSHIELDED TWISTED PAIR) BELDEN 8461
TYPE OR EQUIVALENT

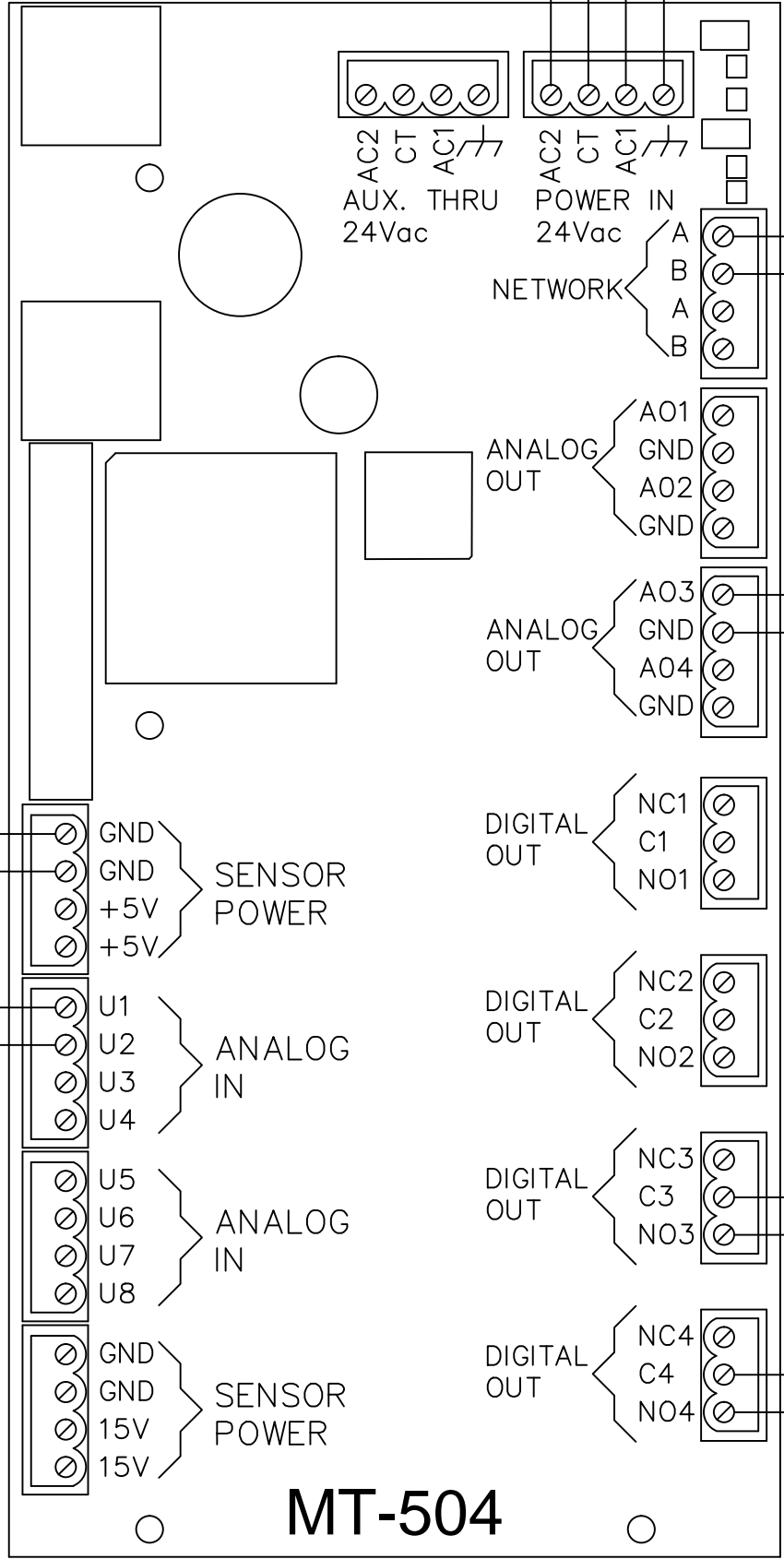
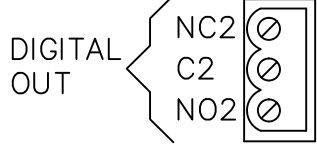
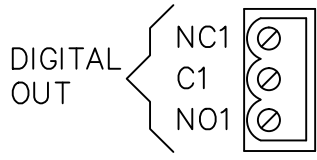
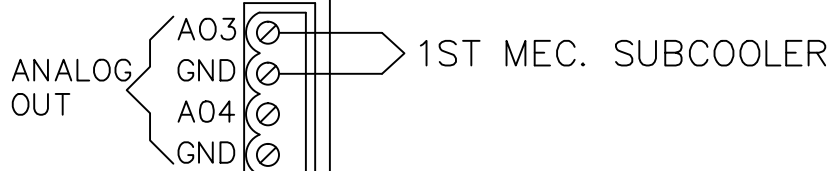
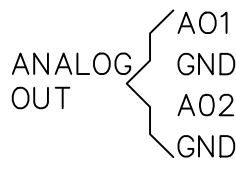

MT-504

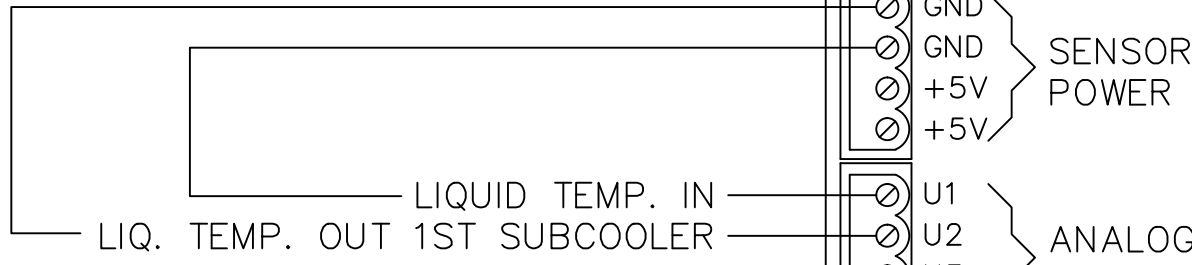

--	----	07
--	----	06
--	----	05
--	----	04
--	----	03
2014-11-12	Update Logo & Adress	02
2012-05-16	Modification on DATA Description	01
DATE	DESCRIPTION	REV.

SYSTEM :
REFRIGERATION

AUTOMATISATION / CONTROL :



Parker
Micro Thermo Technologies™
12855 Rue Brault, Mirabel
Quebec, Canada, J7J 0C4
Tel: (450) 668-3033
Fax: (450) 668-2695

TITLE:
**MT-504 MECHANICAL
SUBCOOLER**

PART# :
9XX-504P

Drawn By : G.Q.	Designed By : L.M.	Approved By : A.H.	Revision : 02
Scale : N.T.S	Date : 2004-08-23	File Name : A-306 MEC. SUB.	